

Schneider
FENSTER • TÜREN

TÜREN

klassisch Modell / Seite

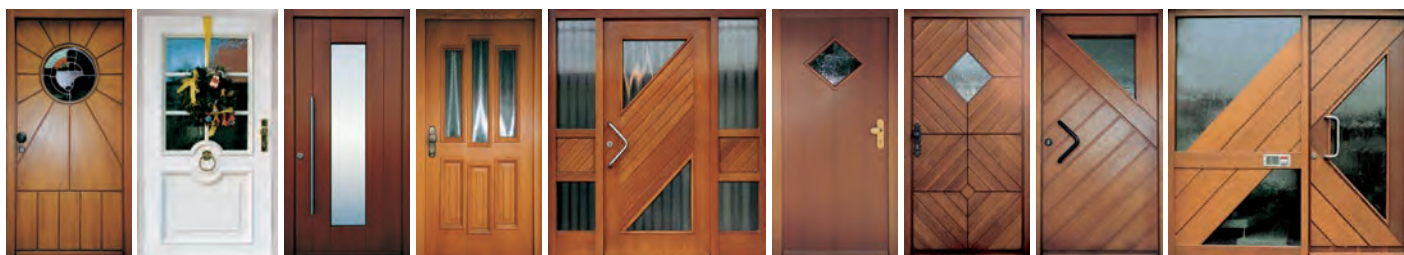

1000/12 1050/12 1100/12 1150/13 1200/13 1250/13 1300/13 1350/13 1400/14

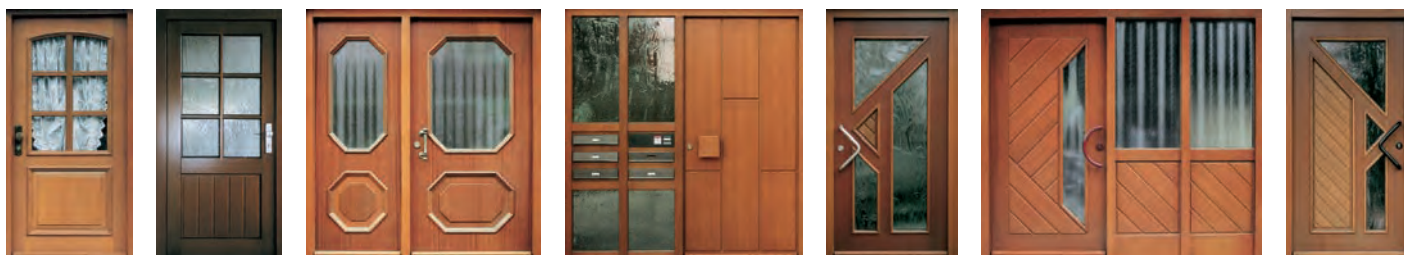

1450/14 1500/14 1550/14 1600/15 1700/15 1750/15 1800/15



1850/16 1900/16 2000/17 2100/17 2150/17 2200/17 2250/18 2300/18



2400/18 2450/18 2500/19 2550/19 2600/19

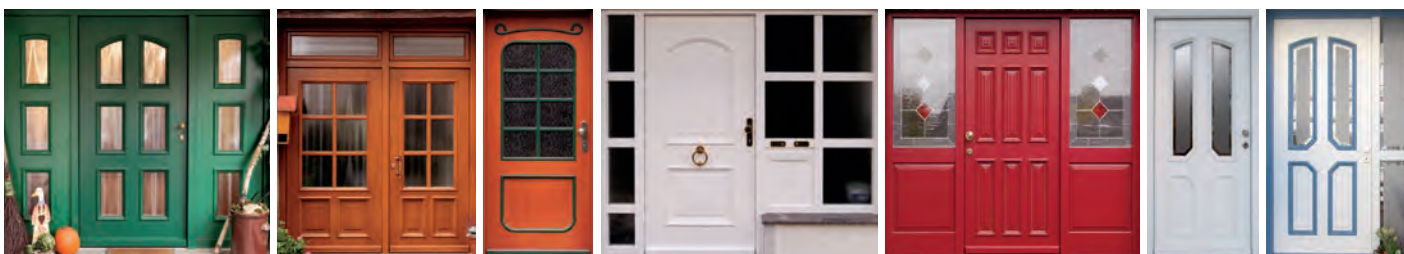

2650/19 2700/20 2750/20 2800/21 2850/21 2900/22 2900/22



2950/22 3000/22 3050/23 3100/23 3150/23 3200/25 3250/25 3300/25 3350/25 3400/25

modern

Modell / Seite



3500 / 28



3500 / 28



3550 / 29



3600 / 29



3650 / 29



3700 / 29



3750 / 29



3800 / 30



3850 / 30



3900 / 30



3950 / 30



4000 / 30



4050 / 30



4100 / 31

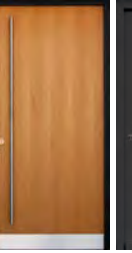

4100 / 31



4150 / 31



4150 / 31



4150 / 31



4200 / 31



4250 / 32



4300 / 32



4350 / 32



4400 / 33



4450 / 33



4450 / 33



4500 / 33



4550 / 33



4600 / 33



4650 / 34



4700 / 34



4750 / 34



4800 / 34



4850 / 34



4900 / 35



4900 / 35



4900 / 35



4900 / 35



4950 / 35



5000 / 36



5050 / 36

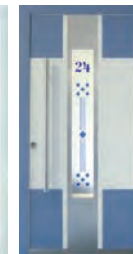

5100 / 36



5150 / 36



5200 / 36



5250 / 37



5250 / 37



5250 / 37



5250 / 37



5300 / 37



5350 / 38



5400 / 38



5450 / 39



5500 / 39



5550 / 39



5600 / 39



5650 / 39



5650 / 39



5650 / 39

modern Modell / Seite



5700 / 40 5750 / 40 5800 / 40 5850 / 40 5900 / 40 5950 / 41 6000 / 41 6050 / 41



6100 / 41 6150 / 42 6200 / 42 6250 / 42 6300 / 42 6350 / 42 6400 / 43 6450 / 43 6500 / 43 6550 / 44

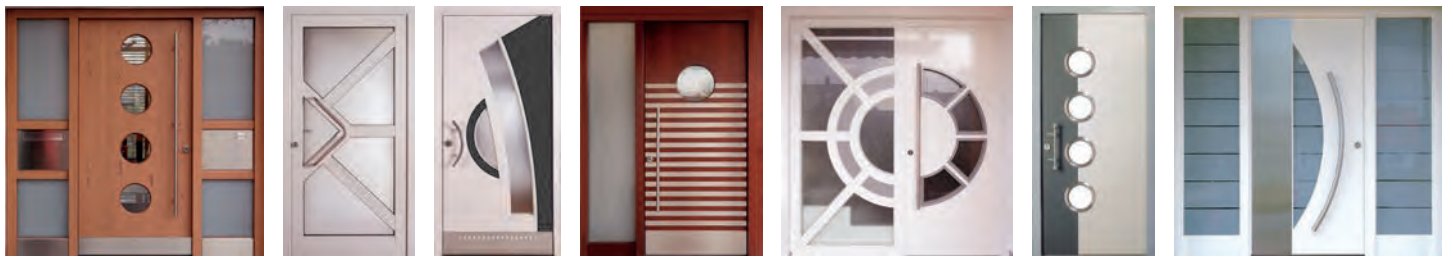

6600 / 44 6650 / 44 6700 / 44 6750 / 44 6800 / 45 6850 / 45 6900 / 45



6950 / 45 7000 / 46 7000 / 46 7000 / 47 7100 / 47 7100 / 47 7100 / 47 7100 / 48

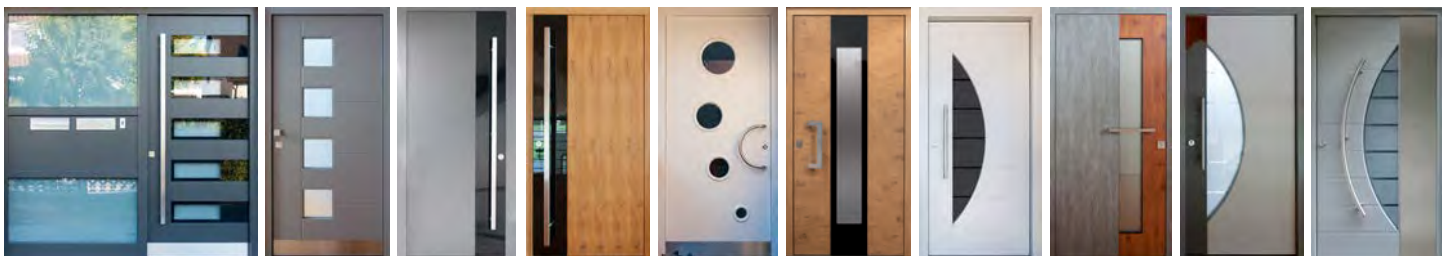

7100 / 48 7150 / 48 7200 / 48 7200 / 48 7250 / 49 7300 / 49 7350 / 49 7400 / 50 7450 / 50 7500 / 50



7550 / 51 7600 / 51 7650 / 51 7700 / 51 7750 / 51 7800 / 52 7900 / 52 7950 / 52

modern Modell / Seite



8000/53 8050/53 8100/53 8150/54 8200/54 8250/54 8300/54 8350/54 8400/54 8450/55



8500/55 8550/55 8600/56 8650/56 8700/57 8750/57

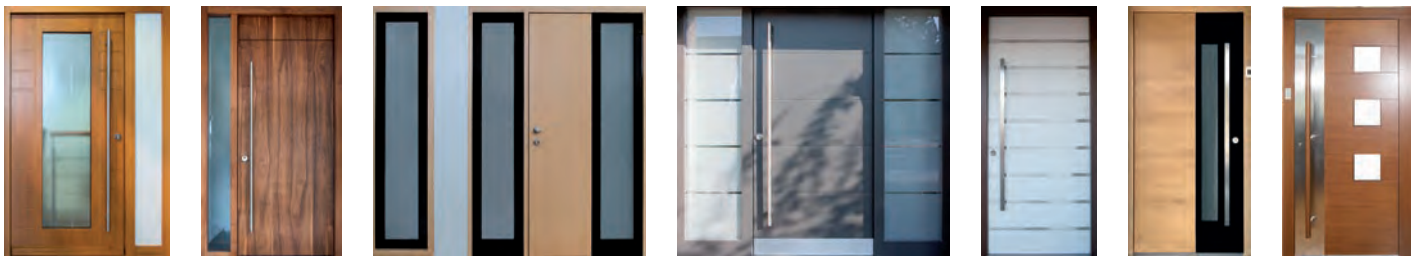

8800/57 8850/57 8900/58 8950/59 9000/59 9050/59 9100/59

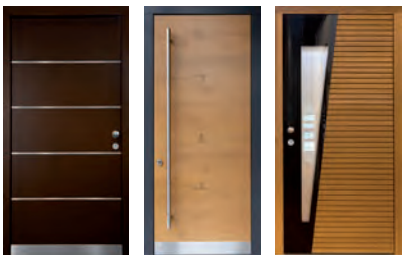

9150/60 9200/60 9250/60

Nebeneingangstüren

Seite 62-63



Glasstrukturen

Seite 64

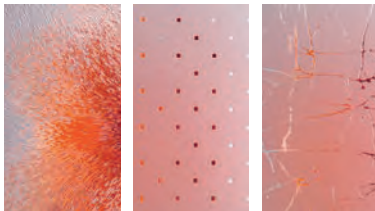

Briefkastenanlagen

Seite 66-67



Schließ-Systeme

Seite 68



Griffe & Beschläge

Seite 70-72



Die Chronik

Von der Gründung bis zum dynamischen,
innovativen Familienunternehmen.



Christian Schneider



Hermann Schneider



Gerhard Schneider



Die heutige Geschäftsleitung:



Wolfgang Schneider



Thomas Schneider

Im Jahre 1901 wurde das Unternehmen Schneider von Christian Schneider gegründet.

Mit Tradition, handwerklichem Können, unternehmerischem Weitblick und Bodenständigkeit wurde – bis heute – die Unternehmensleitung immer vertrauensvoll an die direkte Nachfolge-Generation weiter gegeben.





Das Unternehmen

Unsere Fertigung basiert auf der meisterhaften Vereinigung von solider, handwerklicher Tradition und moderner Technik.

Das Erreichen optimaler Qualität zu vernünftigen Preisen hat dabei oberste Priorität.

Kreativ und immer Bodenständig bereits in der 4. Generation.

Auf über 400 qm Ausstellungsfläche präsentieren wir eine vielfältige, maßge-*Schneider*-te Produktpalette, eine große Auswahl von Hölzern und Farbtönen, diverse Beschläge und Formen, auch in Kombination mit Alu.

Handwerkliches Können hatte schon immer einen „Goldenen Boden“



Das Herzstück der Fertigung ist die computergesteuerte Anlage zur Produktion von unterschiedlichsten Präzisions-Haustüren.





Die Produktion

Leistungsstarker Maschinenpark

Wir entwickeln mit professioneller, handwerklicher Erfahrung und mit aktuellster CAD-Software computerunterstützt bis ins kleinste Detail.

Mit handwerklichem Können und vielseitigem, speziellem Maschinenpark entsteht Stück für Stück Ihre Wunschaustüre.



Verarbeitung

Das gilt für alle unsere Türen:

Die Schneider Haustüren Qualitäts-Parameter

Holzart

In verschiedenen Ausführungen wie z.B. Eiche, Meranti, Kiefer, Lärche.

Türblatt

Unsere Türblätter sind standardmäßig 68 mm stark und ausgestattet mit FKV*-Stabilisatoren. (*Faser-Kunststoff-Verbund)

Prüfung

Geprüft nach DIN EN 1121, Prüfklima $c d e = 80^{\circ} C$ Hitzebestrahlung und Toleranzklasse 3 nach DIN EN 12219:2000-06

Rahmenbau

Ausfertigung mit Schlitz und Zapfen bzw. gedübelt.

Beschläge

3 Markenbänder 3-D-verstellbar, Haustürens Schloss mit Mehrfach-Verriegelung, Sicherheits-Schließbleche verschraubt, thermisch getrennte Schwelle.

Dichtung

Doppelte Silikon-Dichtung im Falz 1-mal umlaufend sorgt für optimale Wärme- und Schalldichtung.

Hochwertige Oberflächenbeschichtung

ADLER Aquawood Protor 2 Komponenten Haustürbeschichtung. 2 K Beschichtung zeichnet sich durch eine hohe Härte und ausgezeichnete Kratzfestigkeit aus, vergleichbar mit der Oberfläche von Autolacken. Sehr gute chemische Beständigkeit, insbesondere Creme- und Fettbeständigkeit. Ausgezeichnete Optik vergleichbar mit einer Möbeloberfläche. Sehr gute UV-Beständigkeit.

Verglasung

Wärmeschutz-Isolierglas mit verschiedenen Ornamenten, Bleiverglasungen oder Designer-Gläsern.

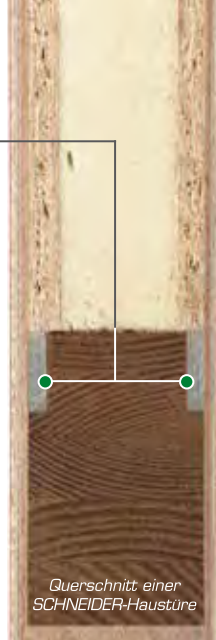

Rohlingstüre Typ Thermosafe 100
Rahmenbreite 81 mm
Rahmenstärke 74 mm
Flügelstärke 100 mm



Rohlingstüre Ultrahaus Effizienzhaus
Rahmenbreite 81 mm
Rahmenstärke 84 mm
Flügelstärke 84 mm



Rohlingstüre Ultrahaus Effizienzhaus
Rahmenbreite 81 mm
Rahmenstärke 78 mm
Flügelstärke 78 mm



Rohlingstüre Standard mit Seitenteil
Typ Allwetter
Rahmenbreite 81 mm
Rahmenstärke 84 mm
Flügelstärke 68 mm



Rohlingstüre Standard Typ Allwetter
Rahmenbreite 81 mm
Rahmenstärke 68 mm
Flügelstärke 68 mm

Nebeneingangstüre

Rahmenstärke 68 mm
Flügelstärke 68 mm
Flügel Friesbreite 111 mm



Nebeneingangstüre

Rahmenstärke 78 mm
Flügelstärke 78 mm
Flügel Friesbreite 111 mm



Nebeneingangstüre

Rahmenstärke 84 mm
Flügelstärke 84 mm
Flügel Friesbreite 111 mm



Rahmentüre

Rahmenstärke 68 mm
Flügelstärke 68 mm
Flügel Friesbreite 138 mm



Rahmentüre

Rahmenstärke 78 mm
Flügelstärke 78 mm
Flügel Friesbreite 138 mm



Rahmentüre

Rahmenstärke 84 mm
Flügelstärke 84 mm
Flügel Friesbreite 138 mm



Standard
Anuba Duplex 3D
mit PVC Hülsen



Optional
Anuba Duplex 3D
in Edelstahl



Optional (verdeckt)
Simonswerk Tectus 640 D
Edelstahl-Look



Standard
Komfortschwelle



Renovierungs-
schwelle

Technische Daten

Standard einflügelig

Rahmen zu Türflügel flächenversetzt, Rahmen 68 mm stark, Flügel 68 mm stark.

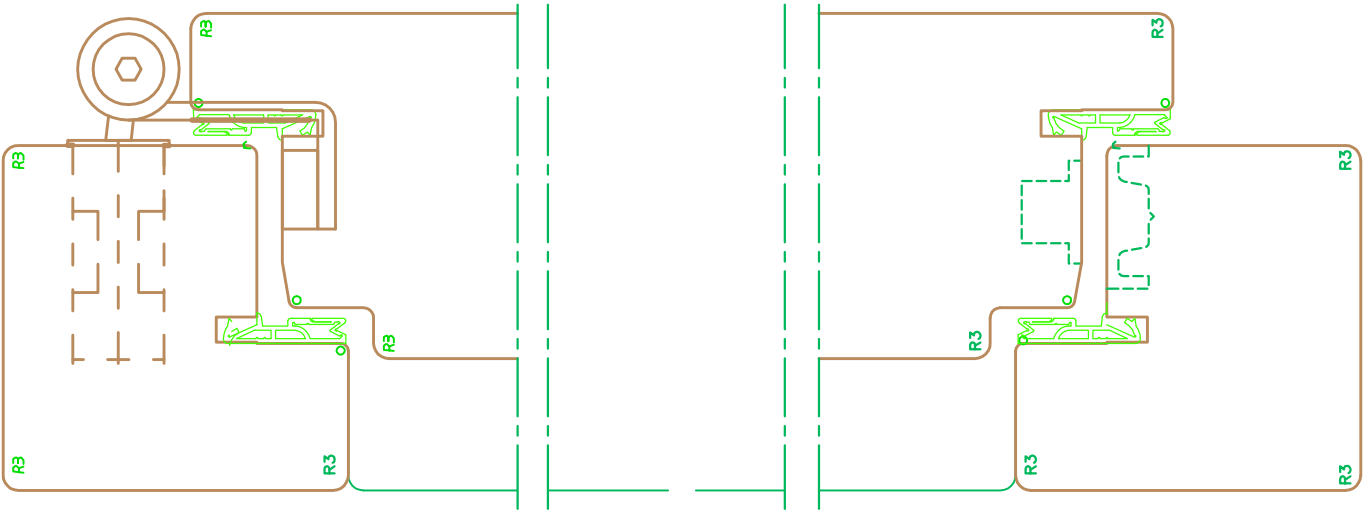

Standard mit Seitenteil

Rahmen zu Türflügel flächenversetzt, Rahmen 84 mm stark, Flügel 68 mm stark.

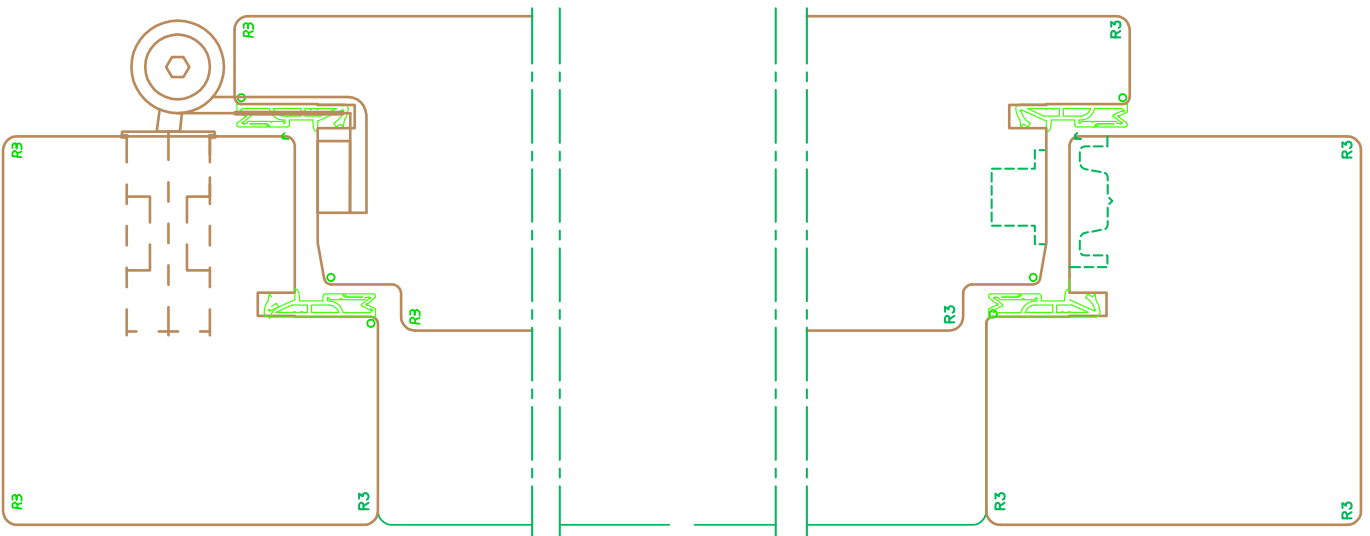

Option

Flügel außen zu Rahmen flächenbündig, innen mit Überschlag.

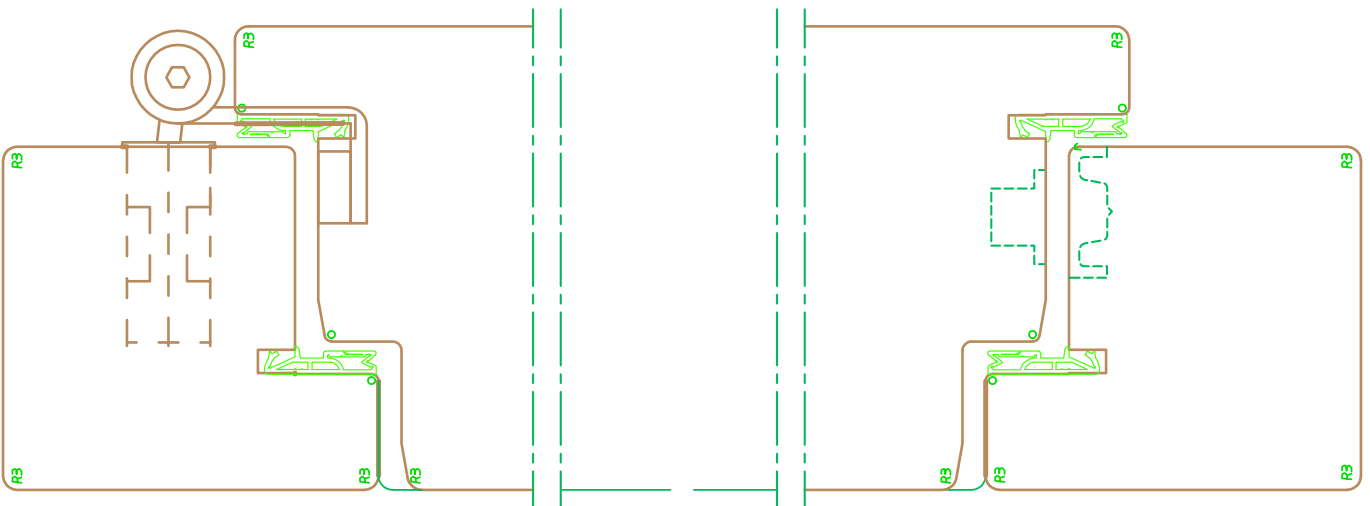

Das Material



Individuelles Design

Holz ist der klassische Werkstoff im Türenbau mit vielseitigen Verwendungsmöglichkeiten.

Holztüren sind – nach heutigen Fertigungstechniken konstruiert und gefertigt – stabile, formbeständige, verzugsfreie und langlebige Bauelemente mit guten bauphysikalischen Eigenschaften.

Durch seine gewachsene Struktur besitzt Holz hohe Festigkeitswerte und lässt sich leicht bearbeiten.

Holztüren können individuell gestaltet und dimensioniert werden.

Sie besitzen gute Wärmedämm-Eigenschaften, eine enorm hohe Dichtigkeit und bieten einen angenehmen Schallschutz.

Schneider setzt Akzente mit innovativen Details in perfekter Verarbeitung.

Zukunftsweisend, Modern, designorientiert:

- gute Stabilität
- gute bauphysikalische Eigenschaften
- hohe Lebensdauer
- hohe Kratzfestigkeit
- große Farbauswahl
- vielfältiges Design in jeder Größe und Ausführung
- umweltfreundlich
- ... und sagenhaft wohnlich!

Das Plus an Qualität:

- geringster Energieaufwand für Bereitstellung, Fertigung, Verarbeitung und Entsorgung
- problemloses Entsorgen bzw. Recycling schließen den natürlichen Kreislauf
- Oberflächenbehandlung mit umweltfreundlichen Lacken und Lasuren
- natürlich gewachsene, unterschiedlichste Holzarten ermöglichen unendliche Gestaltungsvarianten
- behagliches Wohn-Ambiente
- sich anpassende Oberflächentemperatur
- angenehme Griffigkeit
- kein elektrostatisches Aufladen
- Hochwertige Oberflächenbehandlung mit ADLER Aquawood Protor 2 Komponenten Beschichtung
- Große Farbauswahl nach unserer Farbkarte oder nach RAL-Karte
- *Standard Wärmeschutzverglasung mit Klarglas 2-fach Ug 1,1 W/m²k, 3-fach Verglasung oder Strukturverglasung auf Anfrage*
- auch einsetzbar in Sanierungs- und Denkmalbereichen

Mit Holztüren holen Sie sich Natur ins Haus.



Geben Sie Ihrem Eigenheim
eine persönliche Note.
Setzen Sie Akzente.

Die Qualität



Was eine gute Haustüre auszeichnet

SCHNEIDER-Haustüren gewährleisten vielfältige Gestaltungsmöglichkeiten und optimalste handwerkliche Spitzenqualität.

Auch anspruchsvollste Wünsche lassen sich durch grenzenloses Design realisieren und erfüllen jeden individuellen Stil.

SCHNEIDER-Haustüren besitzen durch hochwertige Oberflächen eine extreme Widerstandsfähigkeit und ermöglichen durch eine maximale Wärmedämmung eine effiziente Energieeinsparung.

Modernste Beschlagtechniken bieten enorme Sicherheit und Komfort.

**Wir erwarten Sie gerne
zu einem unverbindlichen Gespräch.**





klassische TÜREN



klassisch

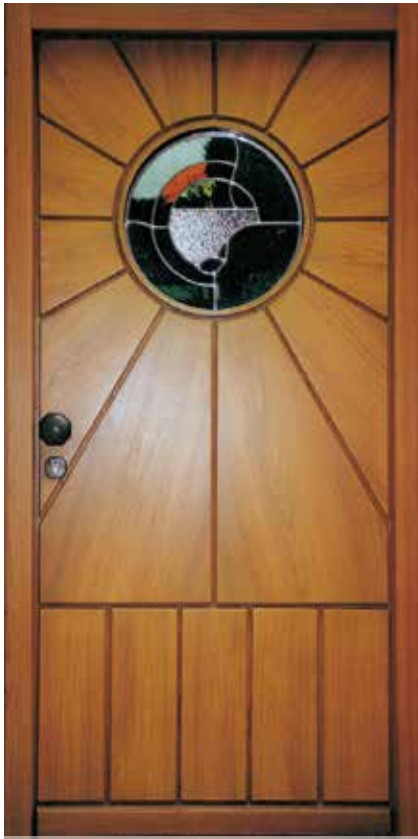

Modell 1000



Modell 1050



Modell 1100



Modell 1050

klassische TÜREN



Modell 1150

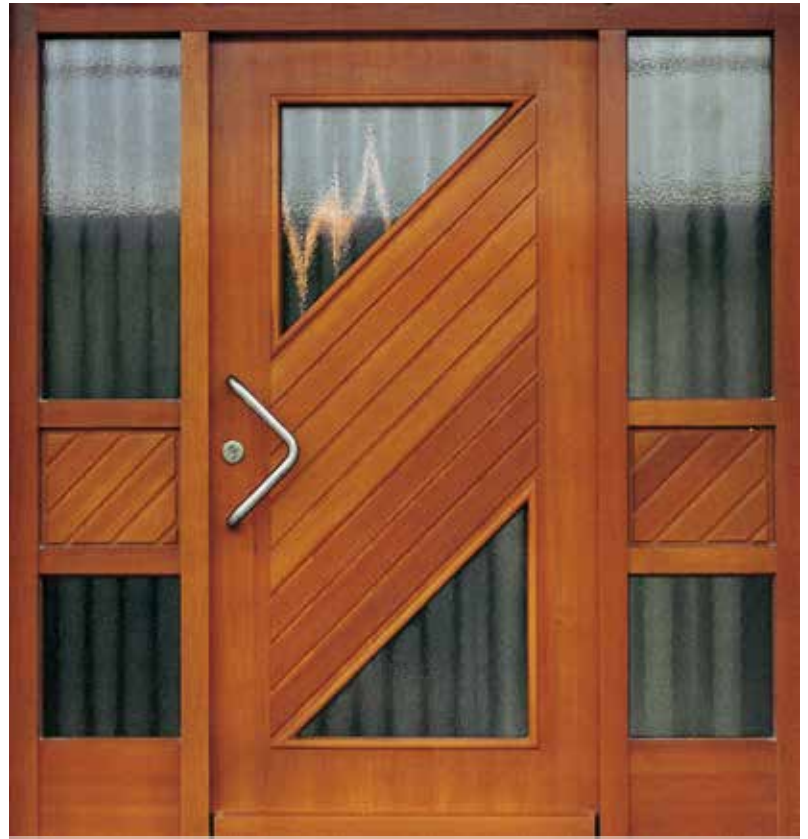

Modell 1200



Modell 1250



Modell 1300



Modell 1350



Modell **1400**



Modell **1450**



Modell **1500**



Modell **1550**

klassische TÜREN



Modell 1600



Modell 1700



Modell 1750



Modell 1800



Modell 1850



Modell 1900



klassische TÜREN



Modell 2000



Modell 2100



Modell 2150



Modell 2200



Modell **2250**



Modell **2300**



Modell **2400**



Modell **2450**

klassische TÜREN



Modell **2500**



Modell **2550**



Modell **2600**



Modell **2650**



Modell **2700**



Modell **2750**

klassische TÜREN



Modell 2800



Modell 2850



Modell **2900**



Modell **2900**



Modell **2950**



Modell **3000**

klassische TÜREN



Modell 3050



Modell 3100



Modell 3150



Modell **3300**

klassische TÜREN



Modell **3200**



Modell **3250**



Modell **3300**



Modell **3350**



Modell **3400**



moderne TÜREN



modern



Modell **3500**



Modell **3500**

moderne TÜREN



Modell **3550**



Modell **3600**



Modell **3650**



Modell **3700**



Modell **3750**



Modell **3800**



Modell **3850**



Modell **3900**



Modell **3950**



Modell **4000**



Modell **4050**

moderne TÜREN



Modell **4100**



Modell **4100**



Modell **4150**



Modell **4200**



Modell 4250



Modell 4300



Modell 4350

moderne TÜREN



Modell 4400



Modell 4450



Modell 4500



Modell 4550



Modell 4600



Modell **4650**



Modell **4700**



Modell **4750**



Modell **4800**



Modell **4850**

moderne TÜREN



Modell 4900



Modell 4950



Modell **5000**



Modell **5050**



Modell **5100**



Modell **5150**



Modell **5200**

moderne TÜREN



Modell 5250



Modell 5300

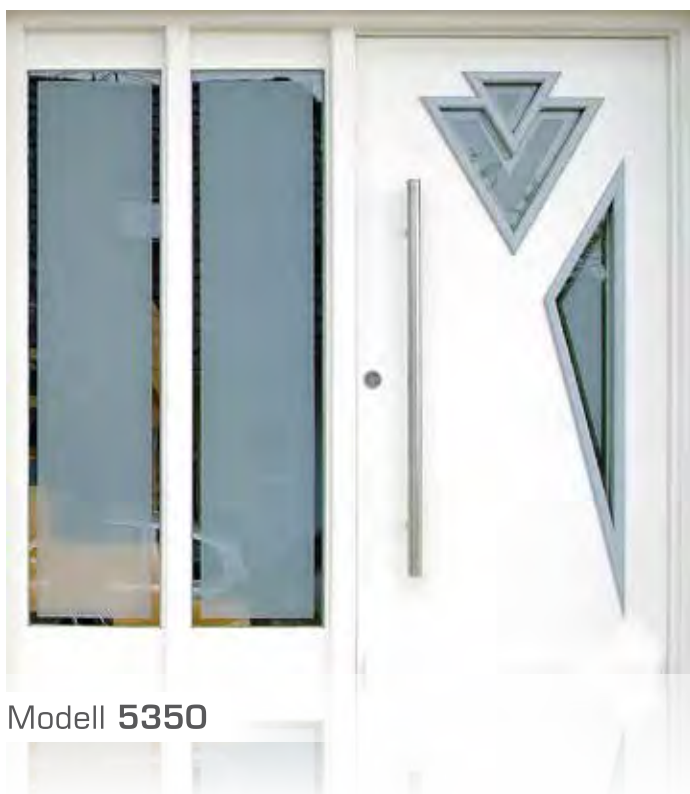

Modell **5350**



Modell **5400**

moderne TÜREN



Modell **5450**



Modell **5500**



Modell **5550**



Modell **5600**



Modell **5650**



Modell **5700**



Modell **5750**



Modell **5800**



Modell **5850**



Modell **5900**

moderne TÜREN



Modell **5950**



Modell **6000**



Modell **6050**



Modell **6100**



Modell **6150**



Modell **6200**



Modell **6250**



Modell **6300**



Modell **6350**

moderne TÜREN



Modell **6400**



Modell **6450**



Modell **6500**





Modell **6550**



Modell **6600**



Modell **6650**



Modell **6700**



Modell **6750**

moderne TÜREN



Modell **6800**



Modell **6850**

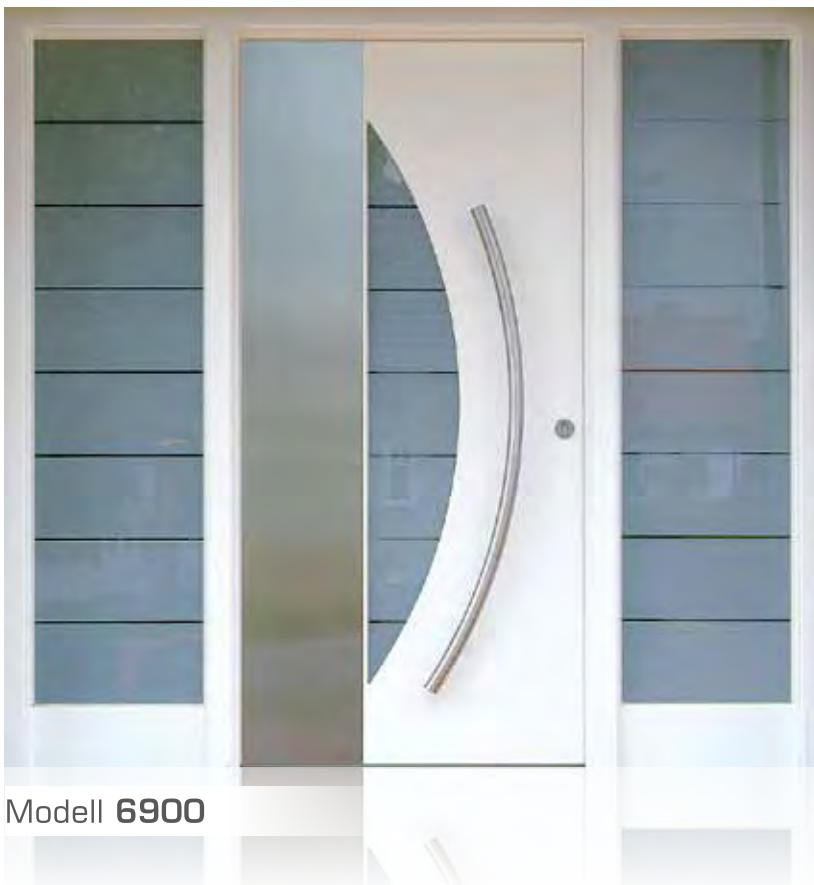

Modell **6900**



Modell **6950**



Modell **7000**



Modell **7000**



moderne TÜREN



Modell 7000



Modell 7100



Modell 7100



Modell 7100



Modell **7100**



Modell **7100**



Modell **7150**



Modell **7200**



Modell **7200**

moderne TÜREN



Modell **7250**



Modell **7300**



Modell **7350**





Modell **7400**



Modell **7450**



Modell **7500**



moderne TÜREN



Modell **7550**



Modell **7600**



Modell **7650**

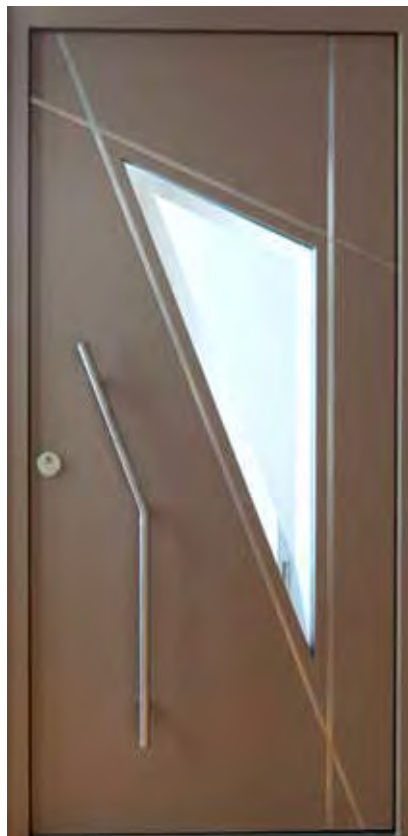

Modell **7700**



Modell **7750**



Modell **7800**



Modell **7900**



Modell **7950**

moderne TÜREN



Modell 8000



Modell 8050



Modell 8100



Modell **8150**



Modell **8200**



Modell **8250**



Modell **8300**



Modell **8350**



Modell **8400**

moderne TÜREN



Modell 8450



Modell 8500



Modell 8550



Modell **8600**



Modell **8650**

moderne TÜREN



Modell **8700**



Modell **8750**



Modell **8800**



Modell **8850**



Modell **8900**



moderne TÜREN



Modell **8950**



Modell **9000**



Modell **9050**



Modell **9100**



Modell **9150**



Modell **9200**



Modell **9250**



Nebeneingangstüren



Typ 1

Durchgehend verglast



Typ 2

Glasfeld oben und unten



Typ 3

Glasfeld oben, Füllung unten

**Von wegen Nebensache
...so wichtig wie der Haupteingang**



Typ 4

Glasfeld oben,
mit aufgesetzten Sprossen
und glatter Füllung unten

NEBENEINGANGSTÜREN

Hochwertige Nebeneingangstüren in Haustürenqualität

Grundausrüstung:

- Holzart in Kiefer oder Meranti
- Massiv gestemmte Rahmentüre, Blockrahmen 81 x 68 mm
- Türflügel 68 mm stark mit Doppelfalz, innenseitig mit Überschlag
- Haustürschloss mit Mehrfachverriegelung (Bolzen / Haken)
- Sicherheits-Schließbleche
- Profilzylinder mit Not- und Gefahrenfunktion, 3 Schlüssel
- Haustürbänder Duplex 3-D verstellbar
- Aluminium-PZ-Schmalrahmen Knopfwechsellgarnitur silber eloxiert
- Thermisch getrennte Aluminium Komfortschwelle silber eloxiert
- Hochwertige Oberflächenbehandlung mit ADLER Aquawood Protor 2 Komponenten Beschichtung
- Große Farbauswahl nach unserer Farbkarte oder nach RAL-Karte
- *Standard Wärmeschutzverglasung mit Klarglas 2-fach Ug 1,1 W/m²k, 3-fach Verglasung oder Strukturverglasung auf Anfrage*



Typ 5

Glasfeld oben,
mit aufgesetzten Sprossen
und aufgedoppelter Füllung unten



Typ 6

Durchgehende Füllung
mit Aufdoppelungen



Glasstrukturen



Chinchilla weiß



Madras Pave



Madras Uadi

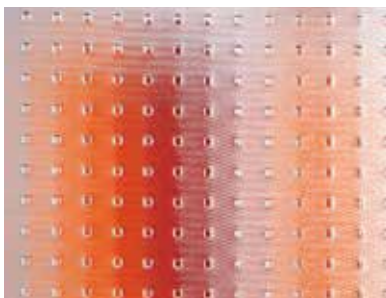

Master Carre



Master Lens



Diese Motivgegenstände stehen immer im Abstand von ca. 50 cm „hinter“ den jeweiligen Strukturgläsern. Die unterschiedlichsten Glas-Strukturmöglichkeiten „entfremden“ bzw. verzerren das Hintergrundmotiv entsprechend.



Orn 504 weiß



Master Point



Satinato



Briefkastenanlagen



RENZ Edelstahl-Aufschaubsystem

Seitenteil durch Querfriese unterteilt mit wärmegeämmter Holz-Sandwichfüllung mit RENZ Edelstahl-Aufschaub-Briefeinwurfsklappe RSK mit RSA 2-Namensschild, von innen verschraubt.

RENZ Edelstahl-Aufschaub-Frontplatte mit RSA 1 Sprechfeld, 1 Klingeltaster und 1 Lichttaster RSA 2, von innen verschraubt.



RENZ PLAN S PREMIUM

- Edelstahl-Thermisch getrennte Frontplatte 34 mm
- gelasertes Sprechfeld mit Spezialadapter für alle handelsüblichen Lautsprecher
- flächenbündiger Klingeltaster und Lichttaster RSA 2
- flächenbündiges RSA 2-Namensschild
- isolierte Briefeinwurfsklappe, umlaufende Gummidichtung mit Zugluftschutz, Geräuschdämpfung und Magnetzuhaltung
- isolierter Einwurfschacht
- extra großer Öffnungswinkel für großformatige Post

BRIEFKASTENANLAGE



RENZ Frontplatte EXCLUSIVE

- Aluminium-Front 24 mm pulverbeschichtet nach RAL, vollflächig isoliert
- gegen Mehrpreis in Edelstahl lieferbar
- RSA 1-Sprechfeld
- flächenbündiger Klingeltaster und Lichttaster RSA 2
- geprägtes Namensschild dadurch völlig flächenbündig
- stabil geprägter Einwurf und Entnahmesicherung
- RENZ System-Klappe RSK Geräuschgedämpft und Wasserableitend



RENZ Frontplatte CLASSIC

- Aluminium-Front 24 mm pulverbeschichtet nach RAL, vollflächig isoliert
- gegen Mehrpreis in Edelstahl lieferbar
- RSA 1-Sprechfeld
- aufgesetzter Klingeltaster und Lichttaster aus Kunststoff
- stabil geprägter Einwurf und Entnahmesicherung
- RENZ Klappe mit Kunststoff Namensschild



Holz-Briefkasten innen
mit Gummidichtung und Schloss

Holz-Installationskasten innen
für bauseitige Sprechanlage aus
Sperrholz in Türenfarbe lackiert



Schließ-Systeme

① KfV AS 2600

- Mehrfachverriegelung schlüsselbetätigt
- Schwenkhaken-Bolzen-Kombination



Optional mit Türspaltsicherung



Grundaussstattung

② KfV AS 2600 Genius

- Automatic Mehrfachverriegelung
- Motorisch verriegeln, motorisch entriegeln.
- Sobald die Tür geschlossen ist, erfolgt eine automatische Verriegelung durch den Motor.
- Alle Verschlusselemente werden herausgefahren.
- Entriegelung von innen über den Drücker, einen Taster oder Gegensprechanlage.
- Entriegelung von außen manuell durch den Zylinderschlüssel oder automatisch über ein externes Zutrittskontrollsystem.

③ GU Security Automatic

- Automatic Mehrfachverriegelung
- Die Automatic Fallenriegel lösen nach dem Zuziehen der Tür automatisch 20 mm aus und sind dann gegen Zurückdrücken gesichert – die Tür wird verriegelt ohne abzuschließen.
- Entriegeln der Fallenriegel mechanisch.
- **Diese Verriegelung ist nicht in Verbindung mit einem E-Öffner lieferbar.**



④ GU Security Automatic mit A-Öffner

- Automatic Mehrfachverriegelung
- Die Automatic Fallenriegel lösen nach dem Zuziehen der Tür automatisch 20 mm aus und sind dann gegen Zurückdrücken gesichert – die Tür wird verriegelt ohne abzuschließen.
- Entriegeln der Fallenriegel motorisch über Zutrittskontrollsystem oder Gegensprechanlage.



⑤ Einzelschließbleche

Im Rahmen bündig eingefräst. (Standardausführung)



⑥ Durchgehende Schließleiste

Optional



⑦ Bandseitensicherung

Besteht aus zwei gleichförmigen, verzahnten Keilsperrrelementen die flächenbündig eingefräst sind.



Griffe & Beschläge

Edelstahl



TG 1070

Innendrücker, Edelstahl



TG 1076

Innendrücker, Edelstahl



TG 1005

Innendrücker, Edelstahl



TG 1183

Innendrücker, Edelstahl



TG 23 0802

Knopf, Edelstahl



TG 23 0829

Knopf, Edelstahl



TG 23 0846

Knopf, Edelstahl,
gekröpft



TG 23 0854

Knopf, Edelstahl,
gekröpft



TG 23 0811

Knopf, Edelstahl



TG 07 0809

Knopf, gekröpft



TG 07 0802

Knopf, gekröpft



TG 7392

Schutzrosette



TG 7393

Schutzrosette
mit Ziehschutz



TG 1795

Drückerrosette, innenseitig,
flächenbündige Ausführung



TG 1796

Schutzrosette, innenseitig,
flächenbündige Ausführung



TG 1796

Schutzrosette, außenseitig,
flächenbündige Ausführung



TG 6188

Griffe, Beschläge & Schlösser

Edelstahl



TG 6514



TG 6526



TG 6535



TG 6538



TG 6548



TG 6540



TG 6613



TG 6621



TG 6683



TG 6669



TG 6635



TG 6653



TG 6662

Messing & Bronze



TG 86 G
Schutzgarnitur,
natur F1,
mit Kernziehschutz



TG 334
Schutzgarnitur,
Messing poliert



TG 1035
Bronze B1



TG 1036
Bronze B1



TG 1371
Bronze B1



Stoßgriff-Varianten, Bronze massiv

TG 9077
Bronze B1



TG 0027
Bronze B1



TG 4019
Außen
Bronze B1



TG 4019
Kernziehschutz
Bronze B1

Für Nebeneingangstüren



TG 300
Schmalrahmengarnitur, Aluminium



TG 310
Schmalrahmengarnitur, Aluminium



TG 07 0809
Knopf, gekröpft

TG 17 1766
ovale PZ Rosette

TÜREN



Entdecken Sie die Vielfalt
auf unserer großen Ausstellungsfläche.



Ein Familienunternehmen mit Tradition.

Innovativ, flexibel und vielseitig.



Schneider
FENSTER • TÜREN

Ihr Fachbetrieb

